



# *Lunar*

## *Operation Manual*

### *Lunar model*

### **ATTENTION!**

This is recommended that only qualified engineers/electricians should perform the installation. Before connecting the controller, in-coming voltage should be checked for in-range voltage rating of controller. Care should be taken that low and high voltage than the device rating would damage the controller.

# **PENTACON**

## **PENTACON ELECTRO-CONTROL (INDIA)**



## CONNECTION

Compare voltage and current of the device. Assemble the apfc relay in capacitor switching panel with the two side clamps. Connect the apfc relay according to wiring diagram. It is strongly recommended the phase given to the relay should be same phase on which ct is installed. If the polarity of ct is reversed the display on screen is `r.ct` (interchange the ct connection)

**Use separate neutral for APFC relay do `t connect with contactors or indicators neutral**

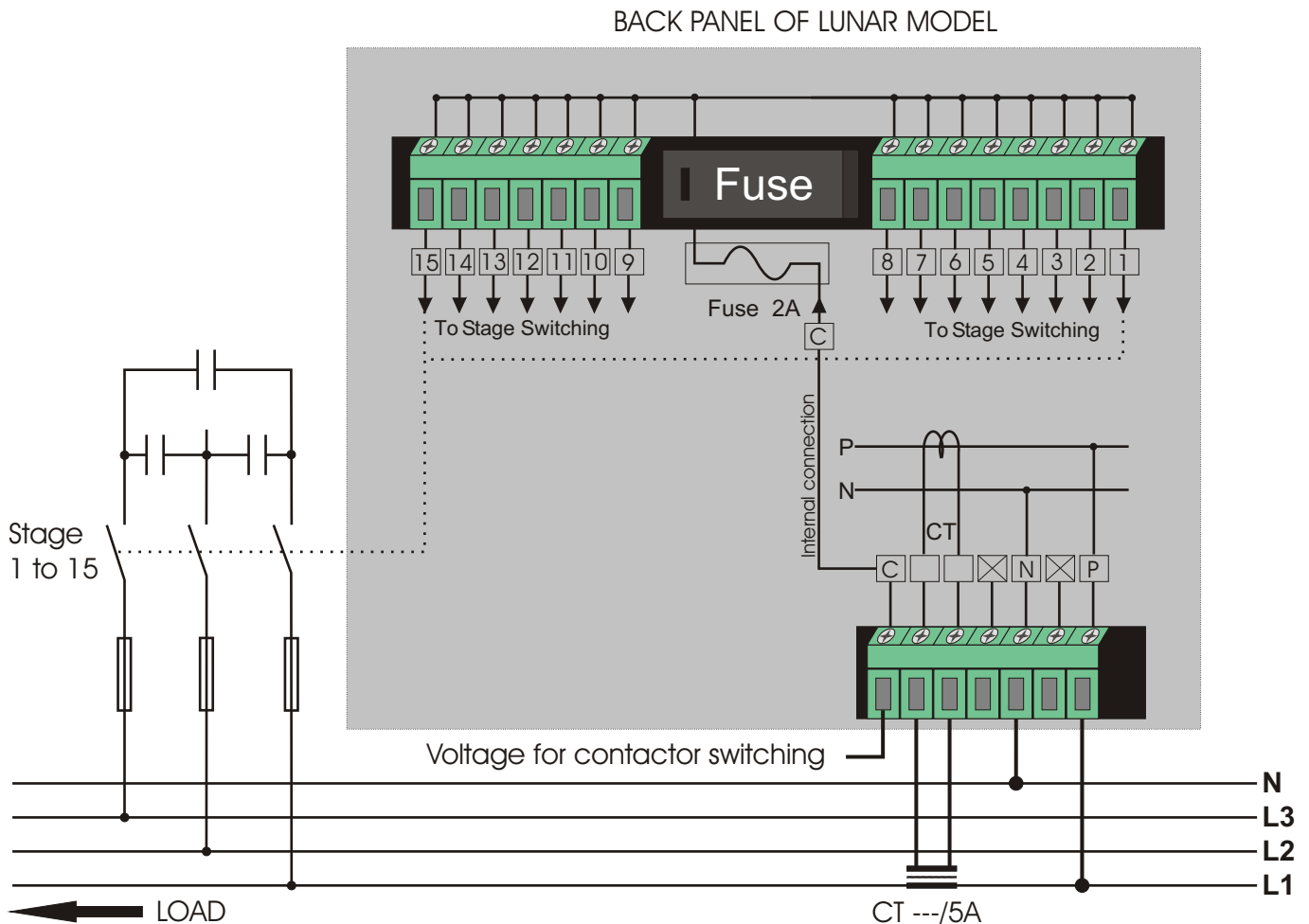



## OTHER PARAMETERS` DISPLAY MODE SELECTION :

For selection to display the other parameters, press and hold the `UP` and `DN` keys simultaneously the screen will change in sequence PF, Ult and AmP release the keys when desired parameter comes on screen. PF is default display, any power failure will lead to display the power factor on priority basis.

Voltage and Ampere are true RMS value, ct primary should be entered to display the actual value. There is no effect of ct ratio on power factor.

**CT Ratio :** CT ratio is require to enter for accuracy of other electrical parameters, there is no effect of CT ratio on power factor.  
Default factory setting is 100/5A.

**Step Delay :** Step delay is the time taken between two continuous on or off the steps. Setting Range - 1 to 20 (0.5 second to 10 seconds)  
Default factory setting - 6 (2 seconds)

**On Delay :** On delay is the time between as H/L led becomes green and first step switched on. It is fold time of step delay.

Setting Range - 1 to 20

Default factory setting - 2

example : On delay = (step delay) x 2 = 4 seconds (factory default)

**Off Delay :** off delay is the time between as H/L led becomes red and first step switched off. It is also fold time of step delay.

Setting Range - 1 to 20

Default factory setting - 3

example : off delay = (step delay) x 3 = 6 seconds (factory default)

**Sensitivity % of CT Current :** This is the minimum set load in % (percentage), above this set value controller comes in normal working mode. (Below this level will display `L.ct` on screen.)  
Setting Range - 1% to 20%, default factory setting - 2%



**Reset on Factory Setting:** In case of any of parameter is not in its proper range or it has been disturbed any how, the controller could be reset on default factory settings.

**Manual capacitor Switching:** `UP` and `DN` keys are also provided an additional function to manually switch on and off the stages. This is not a permanent function, the apfc controller will follow the normal automatic working rule after releasing the key.

**Fuse :** PCB mounted power relays are used inside for stage switching, common terminal of relays are shorted and it is connected to `C` of terminal block. 2 Amp fuse between `C` and common of relays has been provided for protection.

**Capacitor Recommendation:** It is strongly recommended that the capacitor should be in ascending order from stage output 1 to stage output 15 for perfect result.  
Example- 1, 2, 4, 8 and so on.

**Dead Band Explanation:** Dead Band is provided for, to prevent frequently switch on/off the stages on small variation of power factor. It could be understand by the figure as given below.

Power factor is set to 1.00 and dead Band is set to 2. The controller will start to switch on the stages when power factor is below than 0.98 ( $1.00-2=0.98$ ) in lag side and start to switch off the stages when power factor is below than 0.98 in lead side. In between the controller will hold the stages that would be `no action zone`.

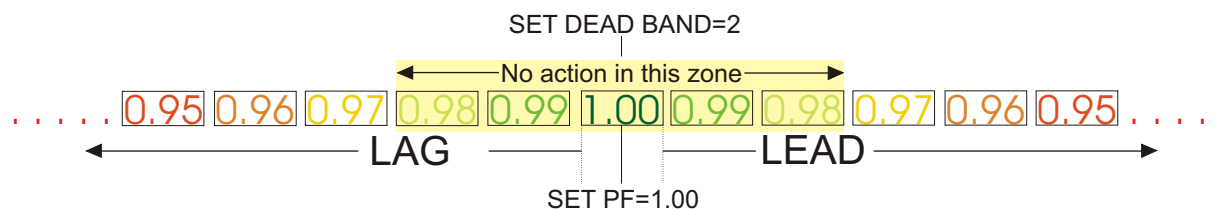

















## INDICATION LED :

LUNAR model is a simple user friendly apfc relay, with primary task of power factor correction. Dedicated led indications are used for indicating parameters and functions.

1. 9 mm seven segment led display - Display shows Power Factor (default indication) and other parameters on selection.
2. VOLT led - Voltage is being display
3. AMP led - Ampere is being display
4. Lag led - Power Factor is lagging.
4. Lead led - Power Factor is leading.
6. 1 to 8/12/15 led - Stage output indication.

**note:** `L.ct` on screen is indication for low/no current. Low current means current is less than set % value of ct primary in `Lod`. In case of, if current is above than set % value of ct primary, check the entire wiring line of ct and their joints if any and ct itself.

## **Explanation of Short Form of Display :**

	Power Factor		Set Load %		Setting (selection)
	Dead Band		CT RATIO		Reverse CT
	Step Delay		VOLTS		Low Current
	On Delay		AMP		Done (act complete)
	Off Delay		CALIBRATION		



## **SETTINGS EXPLANATION :**

There is separate and fast arrangement for setting power factor and dead band.

**SET PF :** Press `SELECT/ENTER` and `UP` key simultaneously at least for 4 seconds, the screen is refreshed by `PF`, now release the keys, last saved pf along with lag or lead indication displays on screen and blinks, now press the UP or DN key to increase or decrease the set power factor, to save the value release the key and press SELECT/ENTER, screen will be refreshed by `don`, the value is saved.

Range - 0.80 lag ---- 1.00 ---- 0.80 lead  
Default set value - 1.00 lead

**DEAD BAND :** Press `SELECT/ENTER` `DN` key simultaneously at least 4 seconds, screen is refreshed by `dbn`, now release the keys the last saved dead band displays on screen and blinks, now press the UP or DN key to increase or decrease the dead band, to save the value release the key and press SELECT/ENTER, screen will be refreshed by `don`. The value is saved.

Range - 1 to 5  
Default set value - 2

**Settings of Variables :** For setting the variables press the key `SELECT/ENTER`, `SET` displays on screen. Release the key first `S.dL` will come on screen, that is step delay now press the key `UP` or `DN` to change the parameters, release the key when the desired parameter comes to set. Now press the `SELECT/ENTER` key, the value of the parameter will be displayed on screen, press `UP` or `DN` key to increase or decrease the value. After setting again press the `SELECT/ENTER` key to save the new value. Display will be refreshed by `don`. The new value is saved.



## SETTINGS FLOW CHART

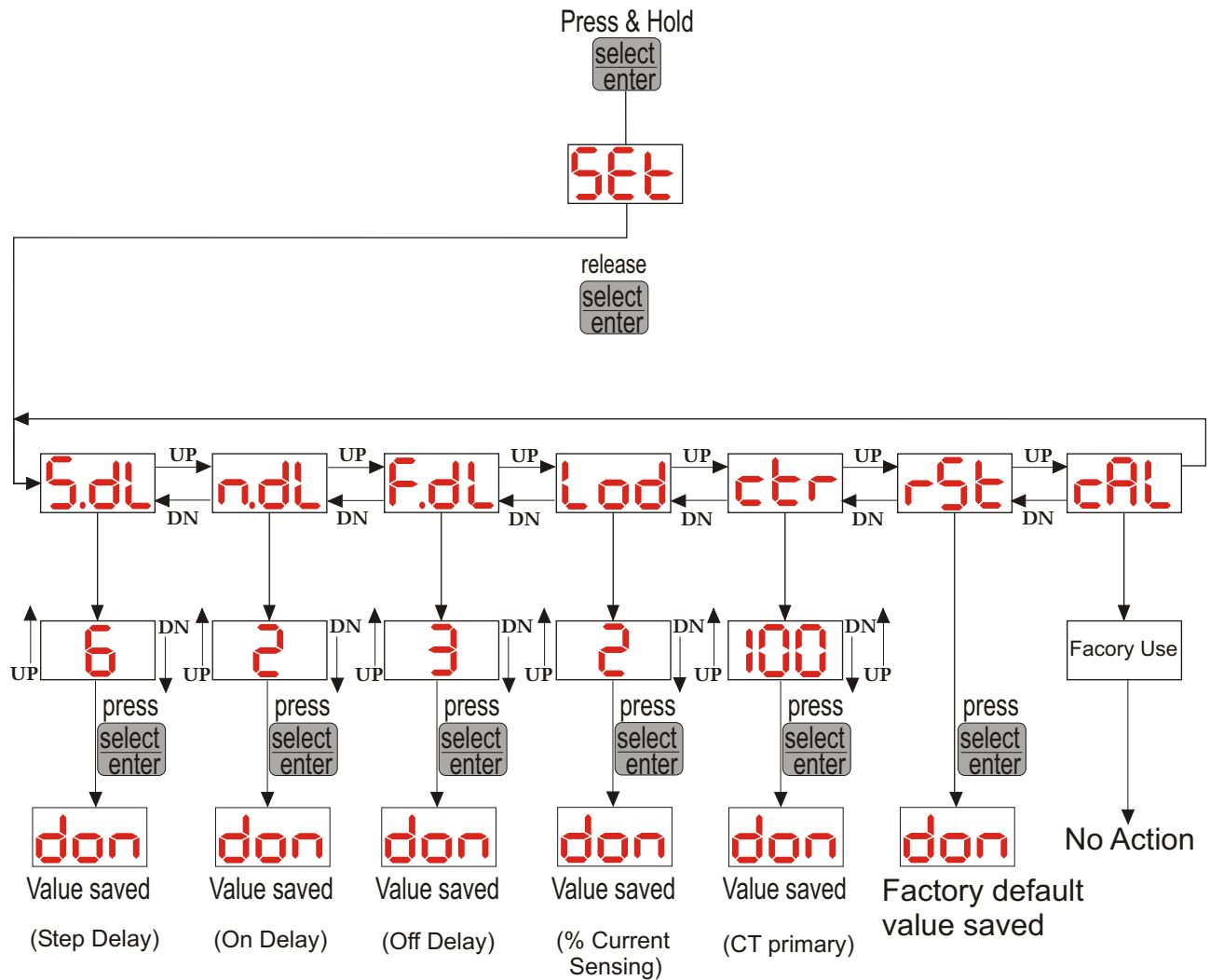



## Technical Specifications :

Working Voltage	: 90V to 285V (Phase & Neutral)
Current Transformer	: 5A direct or through --/5A ct
Class	: 1 to 3, Burden 5VA
Harmonics Effect	: Performance un-efected
Switching Time Delay	: Adjustable, 0.5 second to 10 seconds
Switching Contacts	: 1 Amps, 250V AC (max)
Switching Sequence	: Last in Last out (Special Switching)
Display Power Factor	: 0.01 Lag -----1.00----- 0.01 Lead
Other Display	: VOLT, AMP & Power Factor (default)
Targeted Power Factor	: 0.80 Lag to 0.80 Lead
Nominal Temperature	: -10 degree to +50 degree centigrade
Connection	: Plug in Terminal Block
Stages	: 8, 12, 15 Stages Standard
Dimensions	: 144 mm x 144 mm x 70 mm
Weight	: 750 grams



**PENTACON ELECTRO-CONTROL (INDIA)**

**G-60, Sector-1, Bawana Industrial Area, Delhi-110039.  
India.**

**mob : +91 9312400780, +91 8882224000**

**Web : [www.pentaconindia.com](http://www.pentaconindia.com)**

**E-mail : [pentaconindia@yahoo.in](mailto:pentaconindia@yahoo.in)**